

Standard type:  US / Reinforced type:  US 

**Normally closed
DIP6-pin type
Low on-resistance with
250V/400V load voltage**

**PhotoMOS®
HE 1 Form B
(AQV45○, AQV454H)**

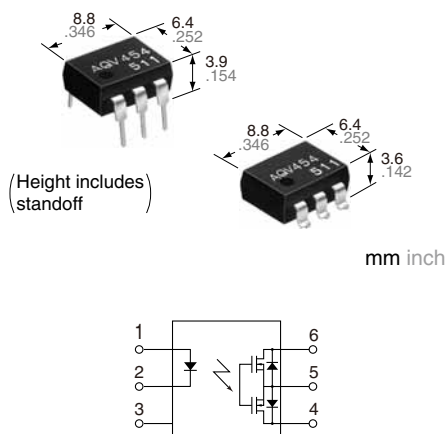

RoHS compliant

FEATURES

1. 1 Form B (Normally-closed) type with low on-resistance

This has been achieved thanks to the built-in MOSFET processed by our proprietary method, DSD (Double-diffused and Selective Doping) method.

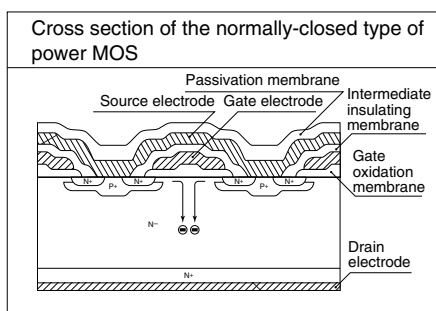

2. Controls low-level analog signals

PhotoMOS feature extremely low closed-circuit offset voltage to enable control of low-level analog signals without distortion.

3. High sensitivity and low on-resistance

Can control max. 0.2 A load current with 5 mA input current. Low on-resistance of typ. 5.5 Ω (AQV453).

4. Reinforced insulation 5,000 V type also available.

More than 0.4 mm .016 inch internal insulation distance between inputs and outputs. Conforms to IEC950 (reinforced insulation).

TYPICAL APPLICATIONS

- Security equipment
- High-speed inspection machines
- Measuring instruments
- Telephone equipment
- Sensing equipment

TYPES

	I/O isolation	Output rating*		Package	Part No.				Packing quantity	
		Load voltage	Load current		Through hole terminal	Surface-mount terminal			Tube	Tape and reel
						Tape and reel packing style				
					Tube packing style	Picked from the 1/2/3-pin side	Picked from the 4/5/6-pin side			
AC/DC dual use	1,500 V AC	250 V	200 mA	DIP6-pin	AQV453	AQV453A	AQV453AX	AQV453AZ	1 tube contains: 50 pcs. 1 batch contains: 500 pcs.	1,000 pcs.
		400 V	150 mA		AQV454	AQV454A	AQV454AX	AQV454AZ		
	Reinforced 5,000 V AC				AQV454H	AQV454HA	AQV454HAX	AQV454HAZ		

* Indicate the peak AC and DC values.

Note: The surface mount terminal indicator "A" and the packing style indicator "X" or "Z" are not marked on the device.

HE 1 Form B (AQV450, AQV454H)

RATING

1. Absolute maximum ratings (Ambient temperature: 25°C 77°F)

Item		Symbol	Type of connection	AQV453(A)	AQV454(A)	AQV454H(A)	Remarks
Input	LED forward current	I_F		50 mA			$f = 100 \text{ Hz}$, Duty factor = 0.1%
	LED reverse voltage	V_R		5 V			
	Peak forward current	I_{FP}		1 A			
	Power dissipation	P_{in}		75 mW			
Load voltage (peak AC)		V_L		250 V	400 V		
Output	Continuous load current	I_L	A	0.2 A	0.15 A		A connection: Peak AC, DC B, C connection: DC
			B	0.3 A	0.18 A		
			C	0.4 A	0.25 A		
	Peak load current	I_{PEAK}		0.6 A	0.5 A		A connection: 100 ms (1 shot), $V_L = \text{DC}$
Power dissipation		P_{OUT}		360 mW			
Total power dissipation		P_T		410 mW			
I/O isolation voltage		V_{iso}		1,500 V AC		5,000 V AC	
Temperature limits	Operating	T_{opr}		-40°C to +85°C -40°F to +185°F			Non-condensing at low temperatures
	Storage	T_{stg}		-40°C to +100°C -40°F to +212°F			

2. Electrical characteristics (Ambient temperature: 25°C 77°F)

Item		Symbol	Type of connection	AQV453(A)	AQV454(A)	AQV454H(A)	Remarks	
Input	LED operate (OFF) current	Typical	I_{Foff}	—	1 mA	0.9 mA	1.4 mA	$I_L = \text{Max.}$
		Maximum			3 mA			
	LED reverse (ON) current	Minimum	I_{Fon}	—	0.4 mA			$I_L = \text{Max.}$
		Typical			0.9 mA	0.8 mA	1.3 mA	
LED dropout voltage	Typical	V_F	—	1.25 V (1.14 V at $I_F=5 \text{ mA}$)			$I_F = 50 \text{ mA}$	
	Maximum			1.5 V				
Output	On resistance	Typical	R_{on}	A	5.5 Ω	11 Ω		$I_F = 0 \text{ mA}$ $I_L = \text{Max.}$ Within 1 s on time
		Maximum			8 Ω	16 Ω		
		Typical	R_{on}	B	2.7 Ω	6.3 Ω		$I_F = 0 \text{ mA}$ $I_L = \text{Max.}$ Within 1 s on time
		Maximum			4 Ω	8 Ω		
	Typical	R_{on}	C	1.4 Ω	3.1 Ω		$I_F = 0 \text{ mA}$ $I_L = \text{Max.}$ Within 1 s on time	
	Maximum			2 Ω	4 Ω			
Off state leakage current	Maximum	I_{Leak}	—	1 μA	1 μA	10 μA	$I_F = 5 \text{ mA}$ $V_L = \text{Max.}$	
Transfer characteristics	Operate (OFF) time*	Typical	T_{off}	—	1.52 ms	1.2 ms	1.8 ms	$I_F = 0 \text{ mA} \rightarrow 5 \text{ mA}$ $I_L = \text{Max.}$
		Maximum			3 ms	2.0 ms	3.0 ms	
	Reverse (ON) time*	Typical	T_{on}	—	0.4 ms	0.36 ms	0.4 ms	$I_F = 5 \text{ mA} \rightarrow 0 \text{ mA}$ $I_L = \text{Max.}$
		Maximum			1 ms			
	I/O capacitance	Typical	C_{iso}	—	1.3 pF			$f = 1 \text{ MHz}$ $V_B = 0 \text{ V}$
Maximum	3 pF							
Initial I/O isolation resistance	Minimum	R_{iso}	—	1,000 M Ω			500 V DC	

*Operate/Reverse time

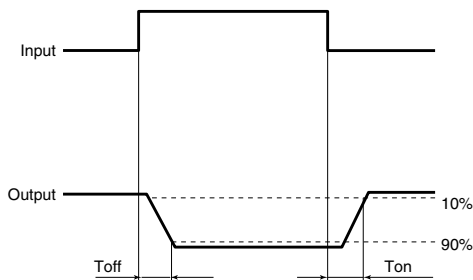

RECOMMENDED OPERATING CONDITIONS

Please obey the following conditions to ensure proper device operation and resetting.

Item	Symbol	Recommended value	Unit
Input LED current	I_F	Standard type: 5 Reinforced insulation type: 5 to 10	mA

■ These products are not designed for automotive use.

If you are considering to use these products for automotive applications, please contact your local Panasonic Corporation technical representative.

REFERENCE DATA

1. Load current vs. ambient temperature characteristics

Allowable ambient temperature: -40°C to $+85^{\circ}\text{C}$
 -40°F to $+185^{\circ}\text{F}$

Type of connection: A

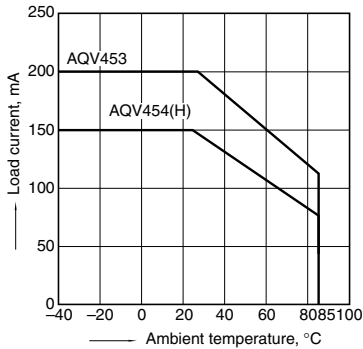

2. On resistance vs. ambient temperature characteristics

Measured portion: between terminals 4 and 6;
 LED current: 0 mA; Load voltage: Max. (DC);
 Continuous load current: Max. (DC)

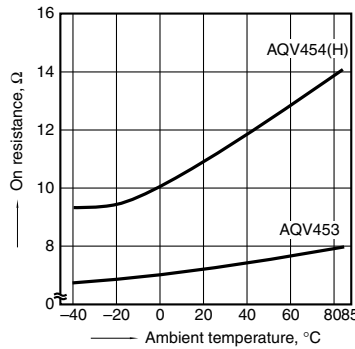

3. Operate (OFF) time vs. ambient temperature characteristics

LED current: 5 mA; Load voltage: Max. (DC);
 Continuous load current: Max. (DC)

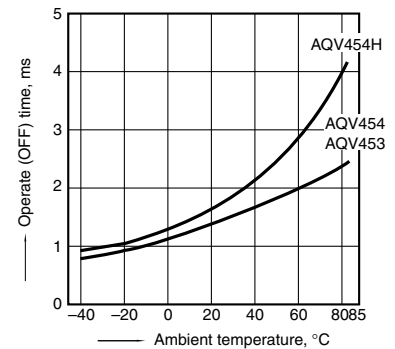

4. Reverse (ON) time vs. ambient temperature characteristics

LED current: 5 mA; Load voltage: Max. (DC);
 Continuous load current: Max. (DC)

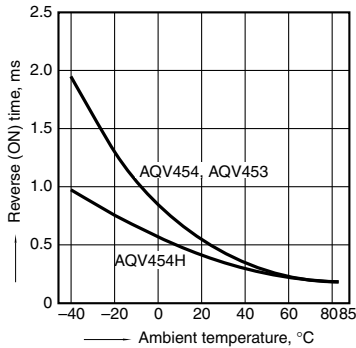

5. LED operate (OFF) current vs. ambient temperature characteristics

Load voltage: Max. (DC);
 Continuous load current: Max. (DC)

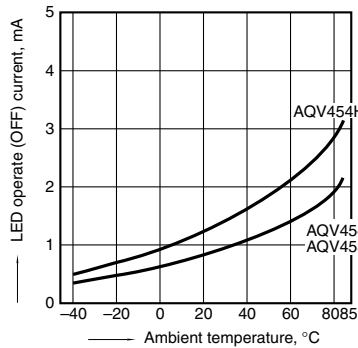

6. LED reverse (ON) current vs. ambient temperature characteristics

Load voltage: Max. (DC);
 Continuous load current: Max. (DC)

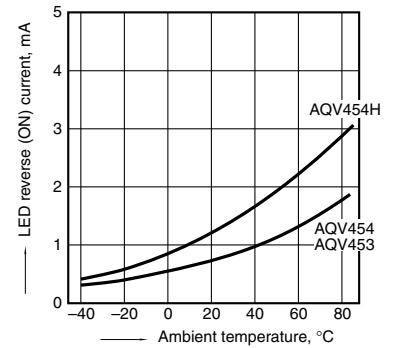

7. LED dropout voltage vs. ambient temperature characteristics

LED current: 5 to 50 mA

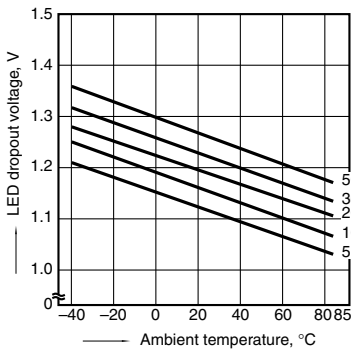

8. Current vs. voltage characteristics of output at MOS portion

Measured portion: between terminals 4 and 6;
 Ambient temperature: 25°C 77°F

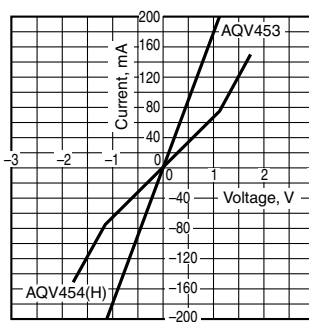

9. Off state leakage current vs. load voltage characteristics

Sample: AQV454;
 Measured portion: between terminals 4 and 6;
 Ambient temperature: 25°C 77°F

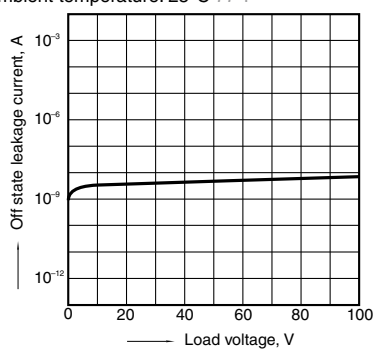

10. Operate (OFF) time vs. LED forward current characteristics

Measured portion: between terminals 4 and 6;
 Load voltage: Max. (DC); Continuous load current: Max. (DC); Ambient temperature: 25°C 77°F

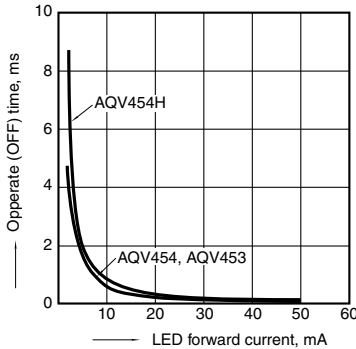

11. Reverse (ON) time vs. LED forward current characteristics

Measured portion: between terminals 4 and 6;
 Load voltage: Max. (DC); Continuous load current: Max. (DC); Ambient temperature: 25°C 77°F

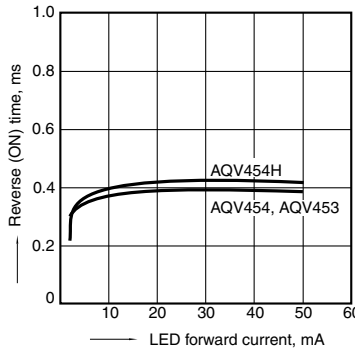

12. Output capacitance vs. applied voltage characteristics

Measured portion: between terminals 4 and 6;
 Frequency: 1 MHz; Ambient temperature: 25°C 77°F

